

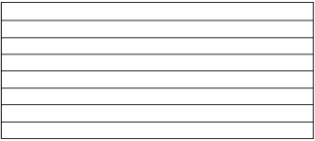









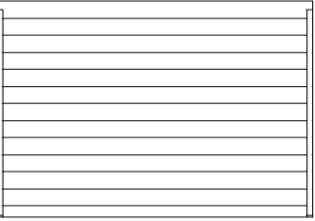

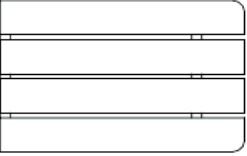
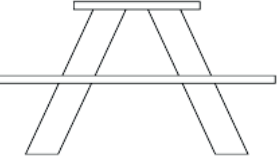
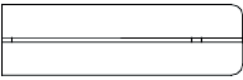

21		Roof of porch	660x1350	2
22		Roof of house	410x1350	1
23		Roof of house	1000x1350	1
24		Roofing		
25		Lath of roofing	25x15x1250	1
26		Lath of roofing	25x15x420	1
27		Lath of roofing	25x15x970	1
28		Verge	15x70x1345	2
29		Verge	15x70x440	2
30		Verge	15x70x1025	2
31		Top of table	600x400	1
32		Frame of table		1
33		Bench of table	600x195	2
A		Wood screws	3x35	111
B		Wood screws	3x30	89
C		Wood screws	3x25	27
D		Wood screws	3,5x16	12
E		Nails		8

# TAWERNA



1

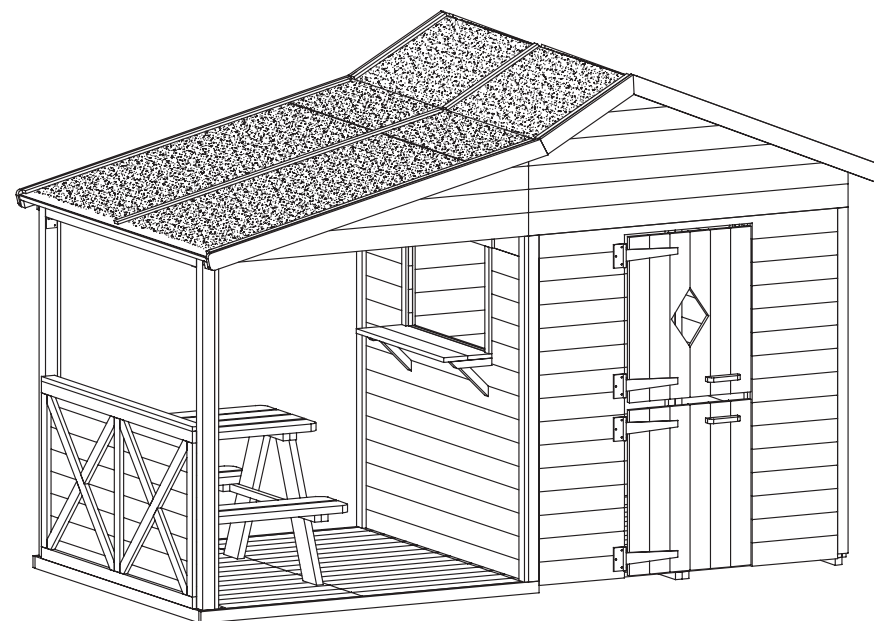
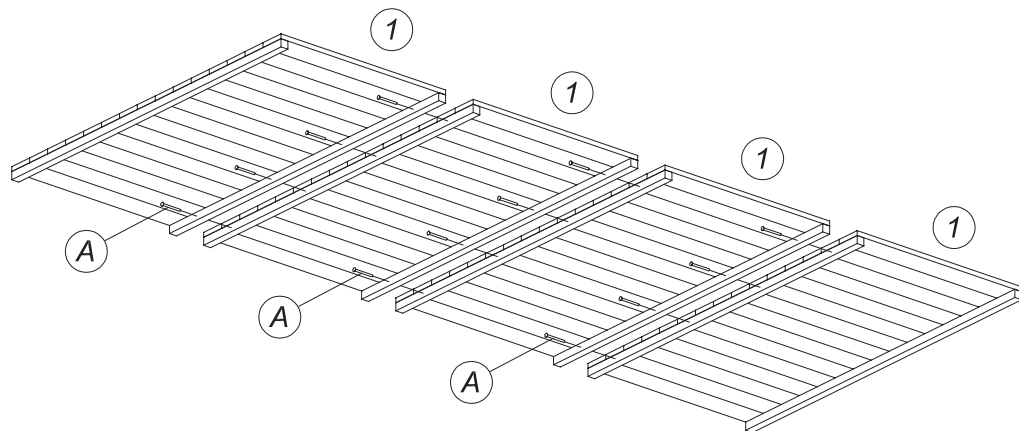

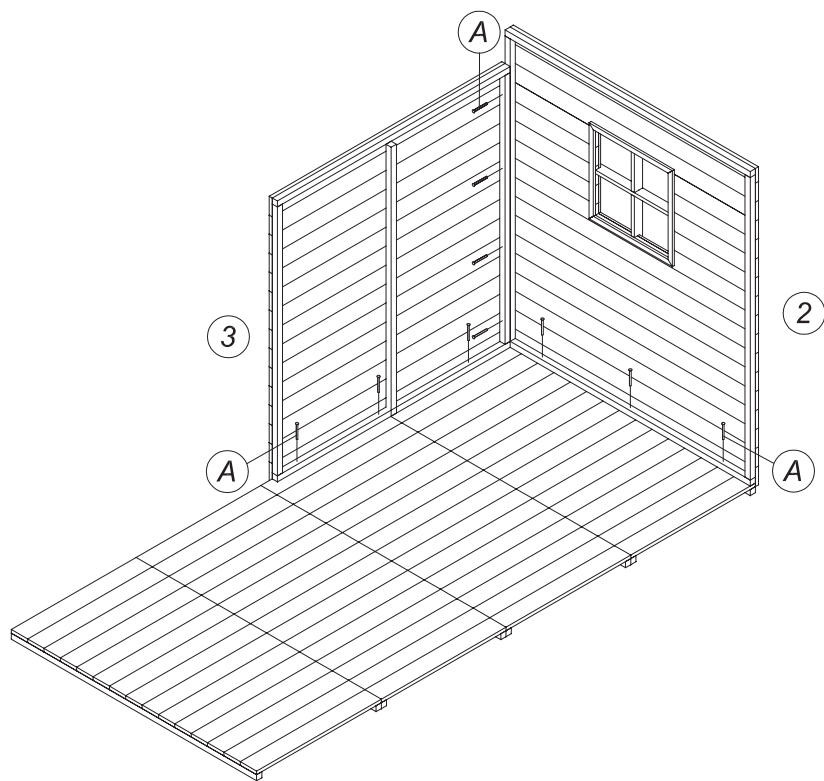

2

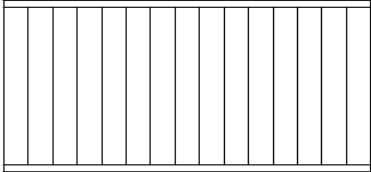
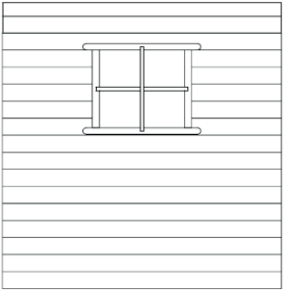
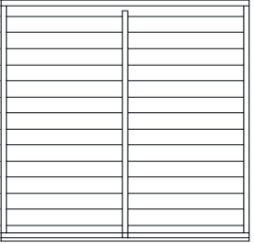
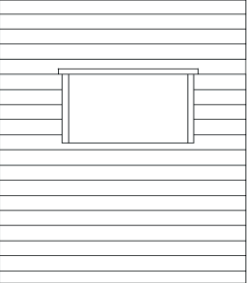
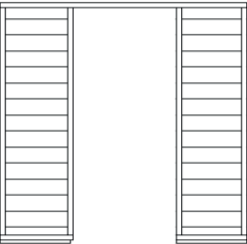

8		Masking lathe of the floor	40x15x1180	5
9		Upper door	460x560	1
10		Lower door	460x560	1
11		Railing	1090x600	1
12		Lath of railing	55x15x1090	1
13		Pillar of the roof	45x45x1210	2
14		Steel angle		6
15		Crossbeam	45x45x1090	1
16		Bracket	630x180	1
17		Shelf bracket	25x25x190	2
18		Frontispiece	1200x500	2
19		Frontispiece	1215x310	2
20		Ridge	35x45x1130	1

List of elements

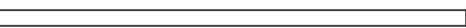
No.		Name	Dimensions	Quantity
1		Floor	1180x595	4
2		Side wall with window	1180x1325	1
3		Rear wall	1120x1185	1
4		Side wall with window	1180x1480	1
5		Front wall	1120x1185	1
6		Masking lathe	40x15x 1160	4
7		Masking lathe of the floor	40x15x 1250	2

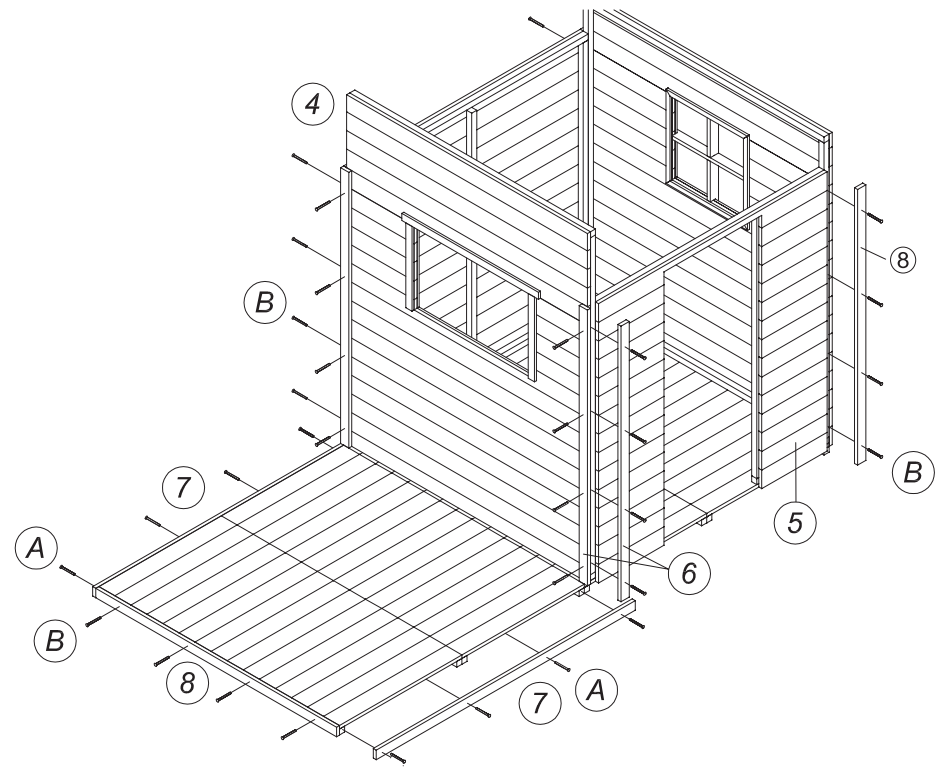

3

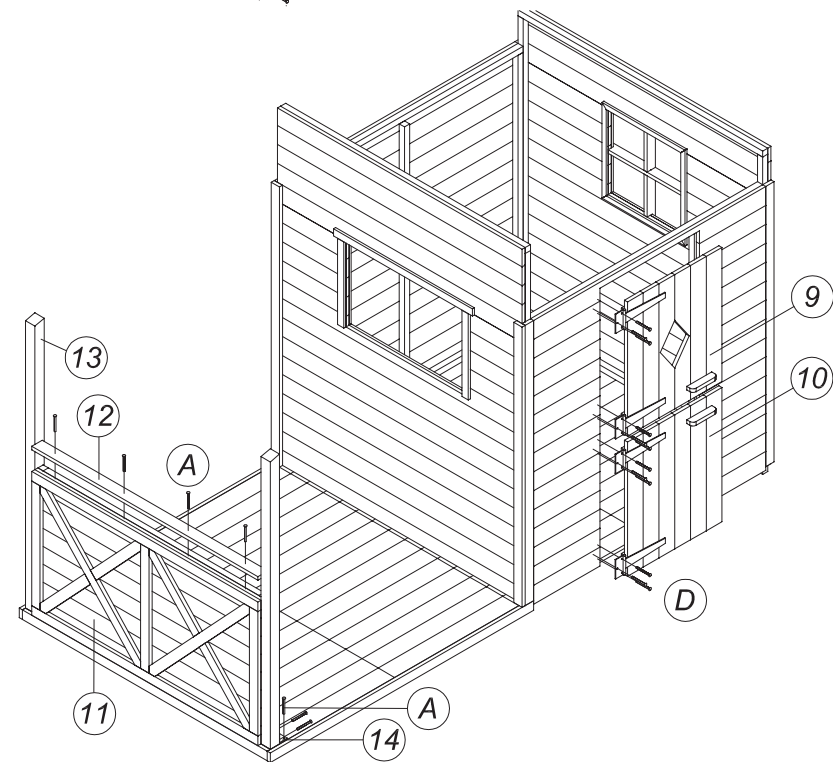

4

5

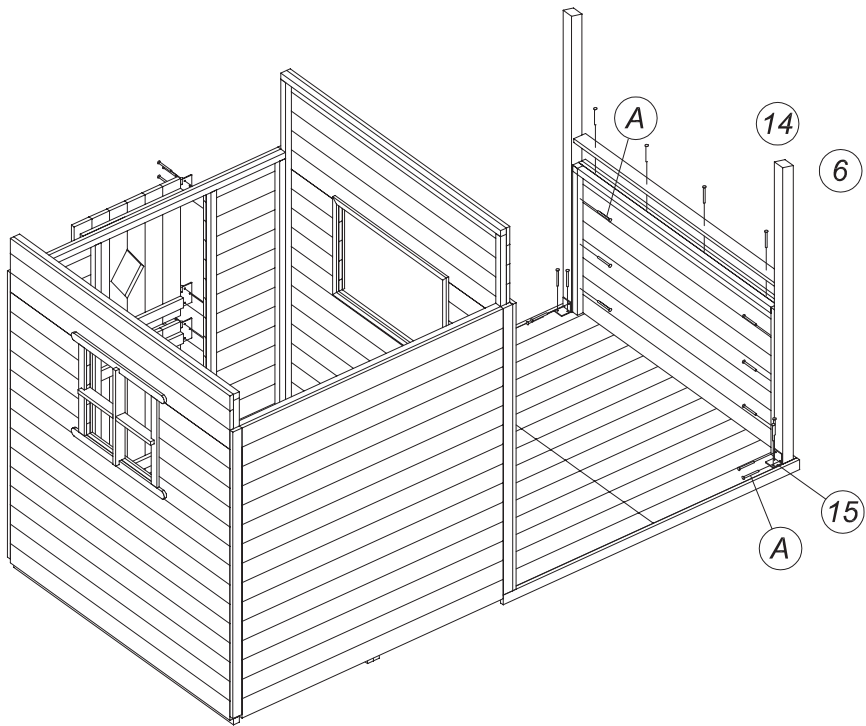

6

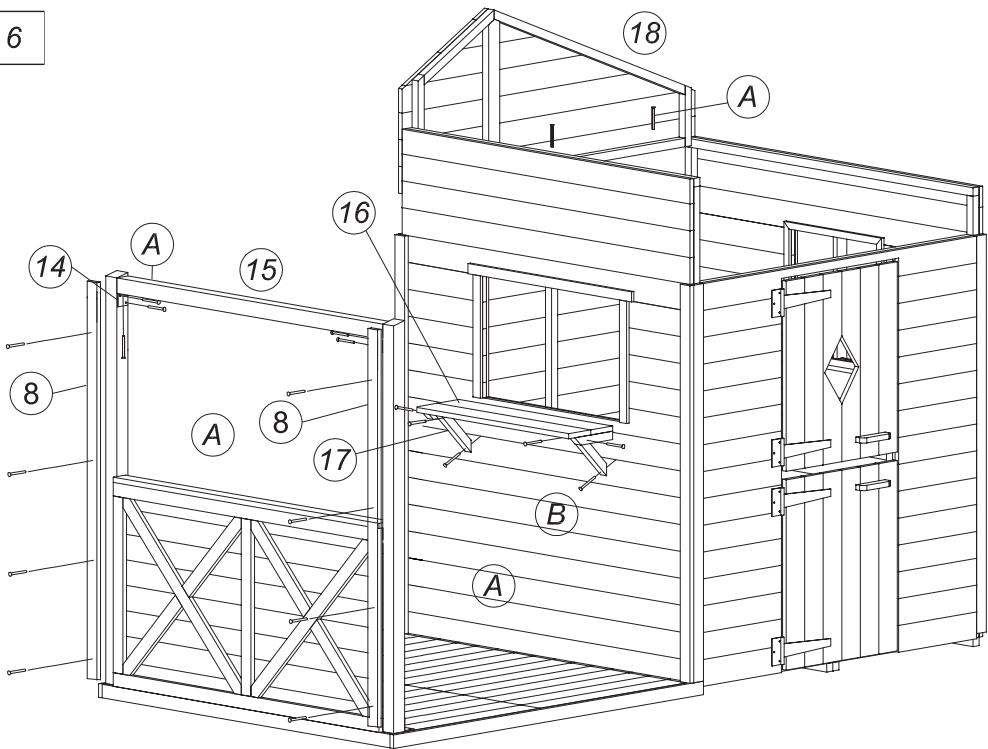

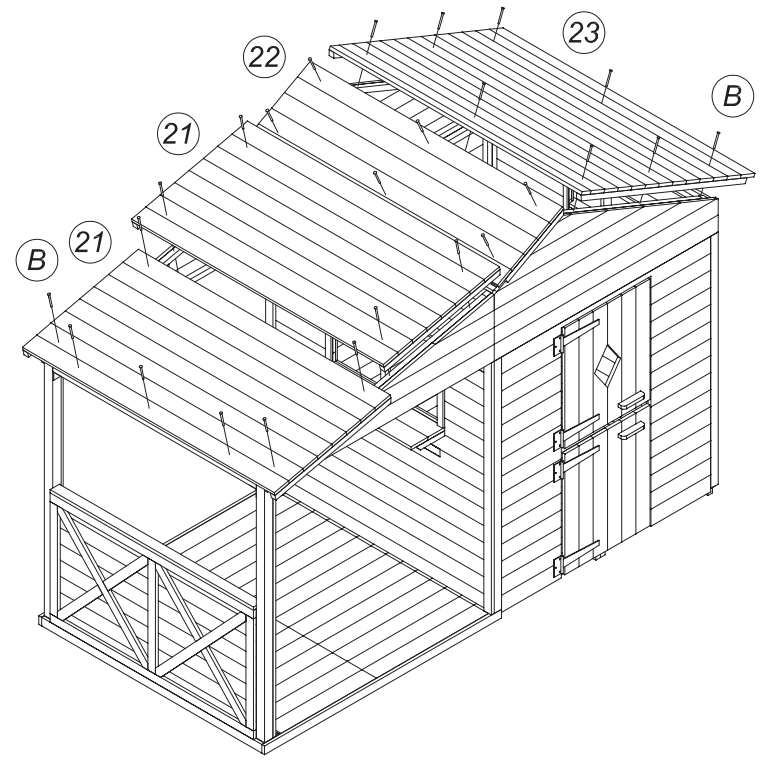
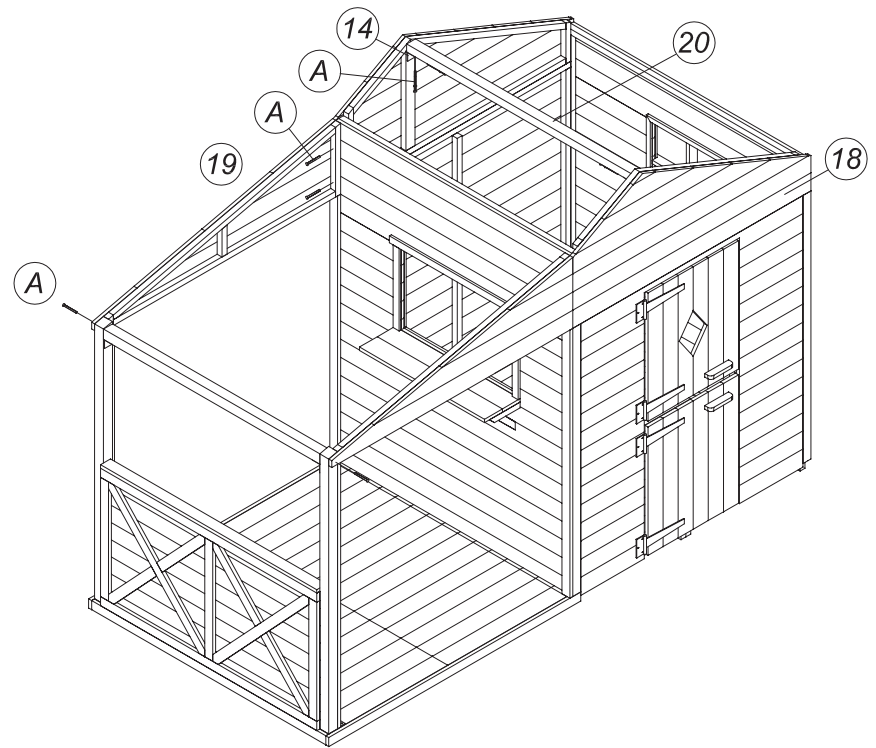

9

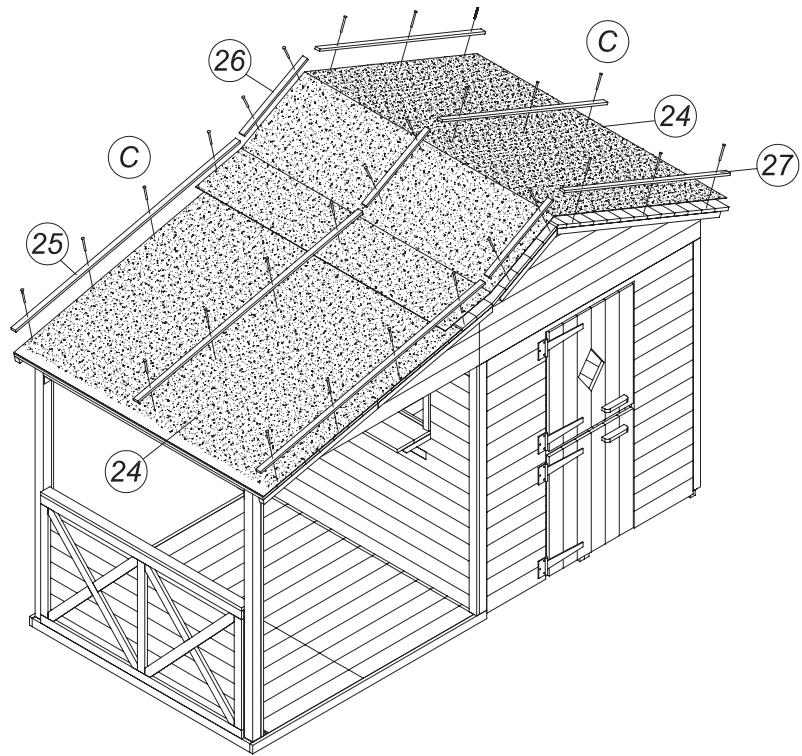

11

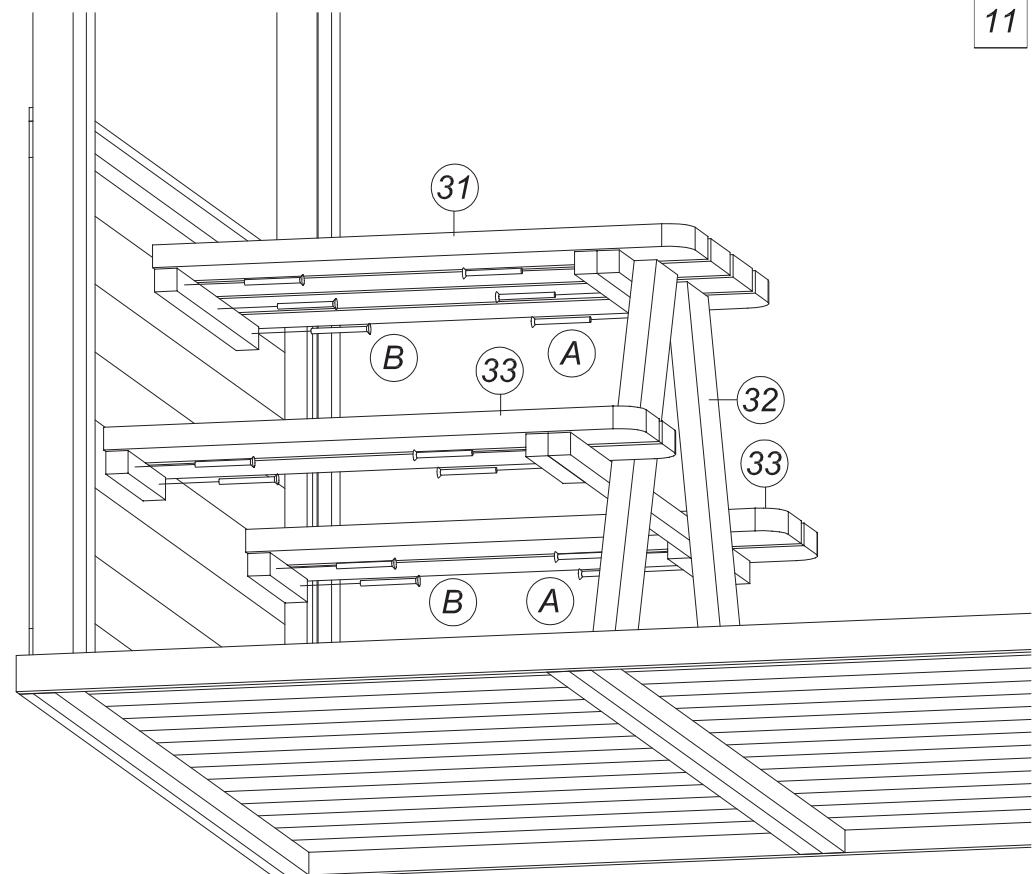

10

